



# Mobile

FilaSorb™ 12

acoufelt  
making quiet

# Product Detail

Product	Mobile
Surface	Ancillary
Composition	100% Polyester
Material	FilaSorb™
Recycled Content	60% min.
Weight	0.49 lb/ft <sup>2</sup> +/- 10%
Dimension	36"W x 16"H x 18"D
	Custom size available upon request
Thickness	12mm   0.47" +/- 10%

# Technical Data

Fire Test Method Number	ISO 9705:1993 Group 1 AS ISO 9705:2003 Group 1 ASTM E84-17a Class A
Indoor Air Quality	Low VOCs emission, formaldehyde and Phenol-free
Light Fastness	ISO 105-B02 1994, 6-7

# Acoustic Performance

Sound Absorption ISO 354-2006 NRC 0.45

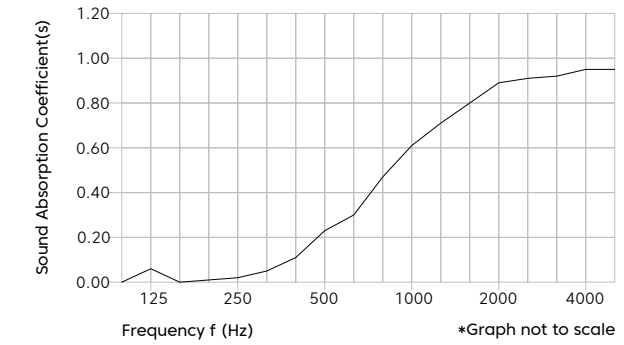

Frequency f (Hz)	125	250	500	1000	2000	4000	NRC
12mm a, No Air Gap	0.06	0.02	0.23	0.61	0.89	0.95	0.45

# Guarantees

Lead Time	Ships in 4-6 weeks
Light Fastness Warranty	10 Years*
Customizable	Yes
	* conditions apply

# Environmental Attributes

- Declare Certification
- LCB Red List Free
- Phenol And Formaldehyde Free
- Low VOC
- CDPH Compliance
- Aligns With Building Standards



**Declare.**

# L-Shaped Design

Plan

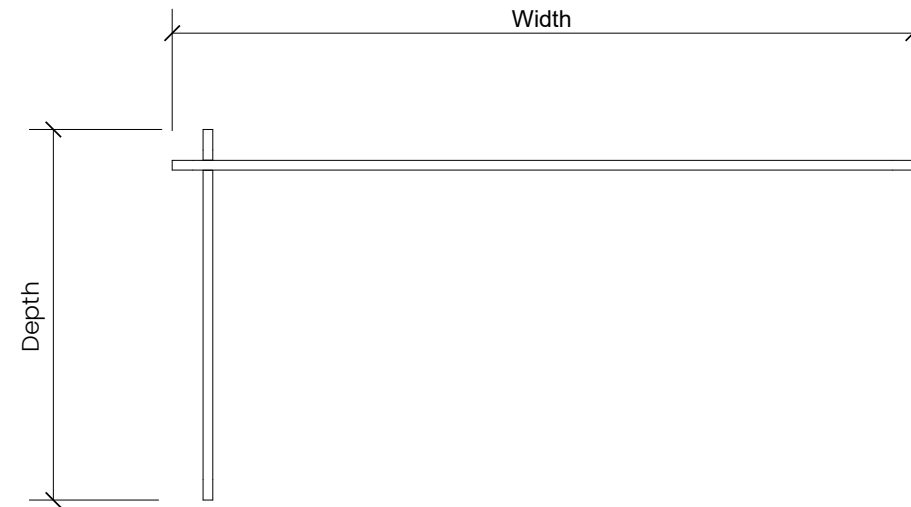

Perspective

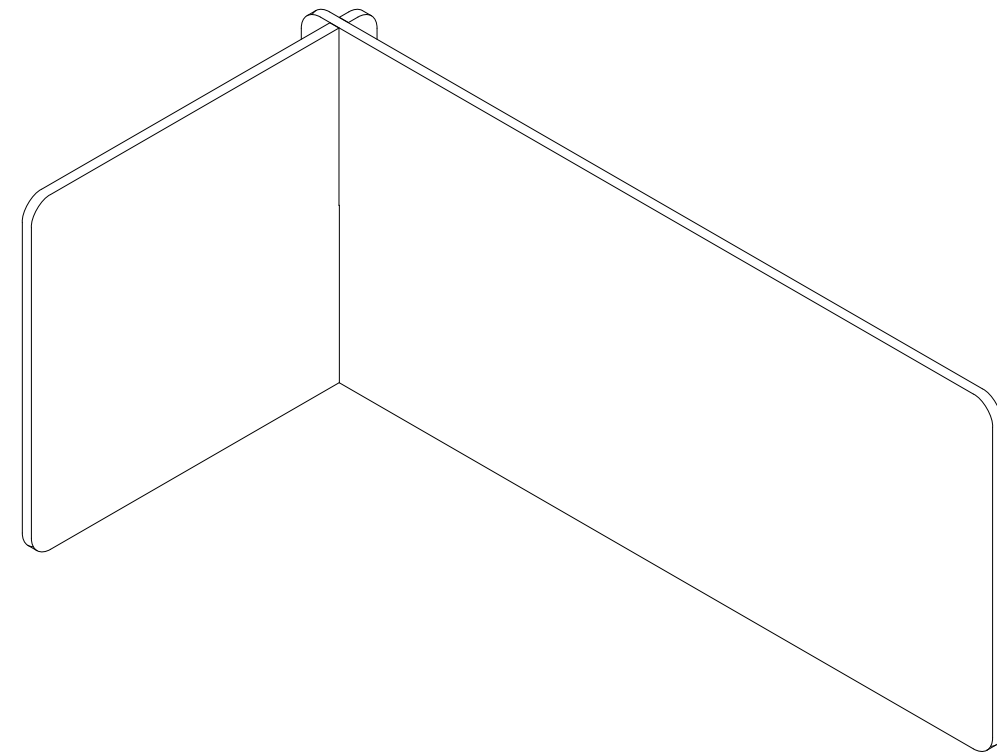

Elevation

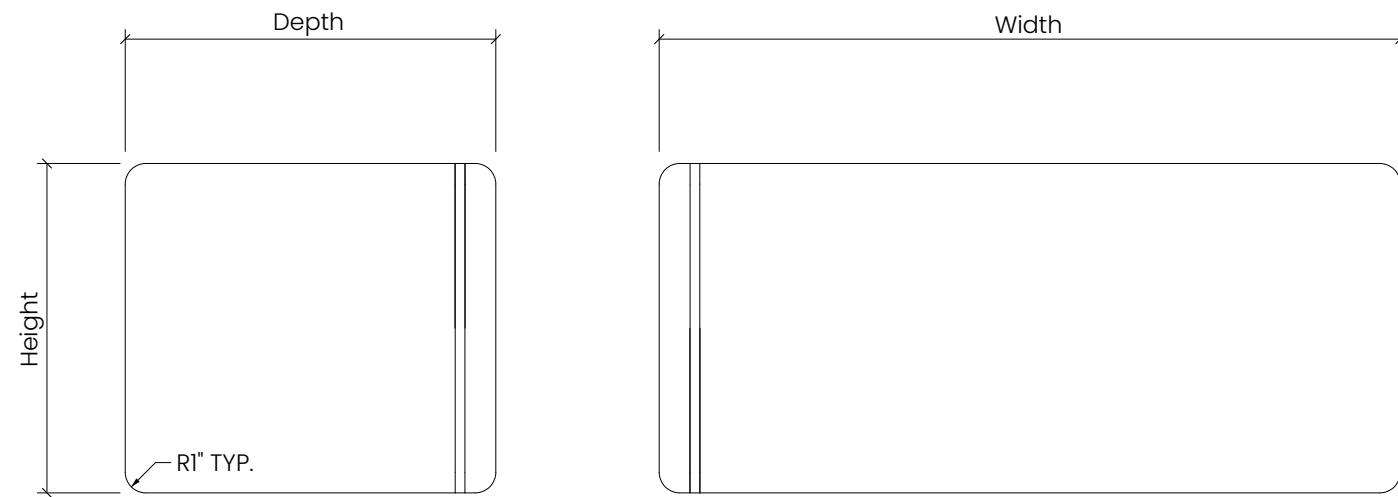

# Colorways

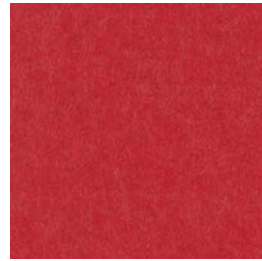

Lipstick Red  
LI14



Carrot  
CA08

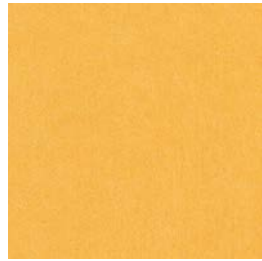

Butter  
BU07



Popcorn  
PO26



Pistachio  
PI25



Wasabi  
WA29



Thistle  
TH28

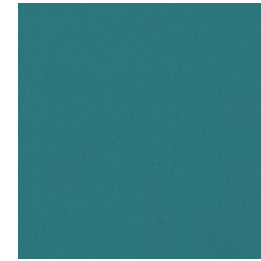

Peacock  
PE20

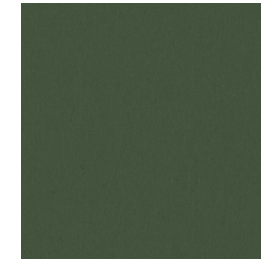

Oregano  
OR18

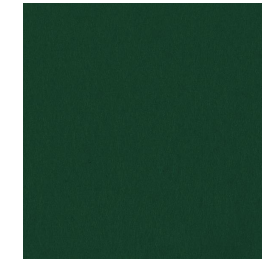

Kale  
KA12



Denim  
DE09



Midnight  
MI16



Azur  
AZ05



Marine  
MA15

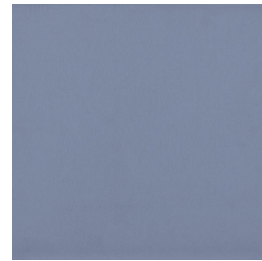

Periwinkle  
PE23

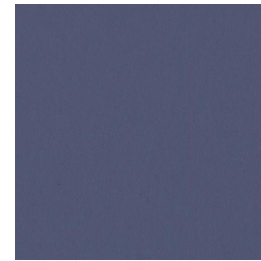

Iris  
IR10



Berry  
BE06

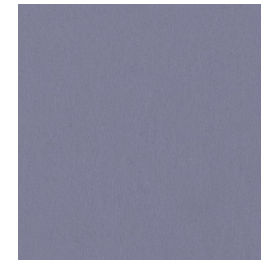

Lilac  
LI13



Peach  
PE19



Peppercorn  
PE22



Piano Black  
PI24



Charcoal  
CH01

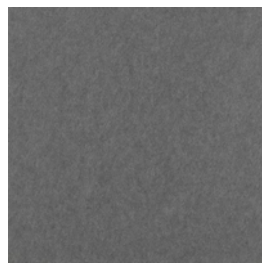

Slate  
SL27



Grey  
GR02



Metal  
ME03



Platinum  
PL04

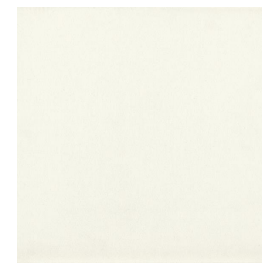

White  
WH12

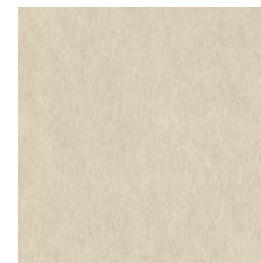

Pearl  
PE21



Ivory  
IV11